



Finesse™

Frameless Pivot Shower Door

6305-37

Features

- Frameless
- 1/4" glass
- CleanCoat technology
- Knob handle
- Out-of-plumb adjustability
- Tempered glass ensures maximum safety and durability
- Anodized aluminum prevents rusting and corrosion

Installation

- Not for use in hospitality.
- For residential use only.

Included Components

Additional Components:
Hardware kit



Codes/Standards

ANSI Z97.1
CPSC 16CFR 1201

STERLING® Warranty - Bath and Shower Doors

See website for detailed warranty information.

Available Colors/Finishes

Color tiles intended for reference only.

Color	Code	Description
-------	------	-------------

DR

N

S

Available Glass Options

Code	Description
------	-------------

Clear

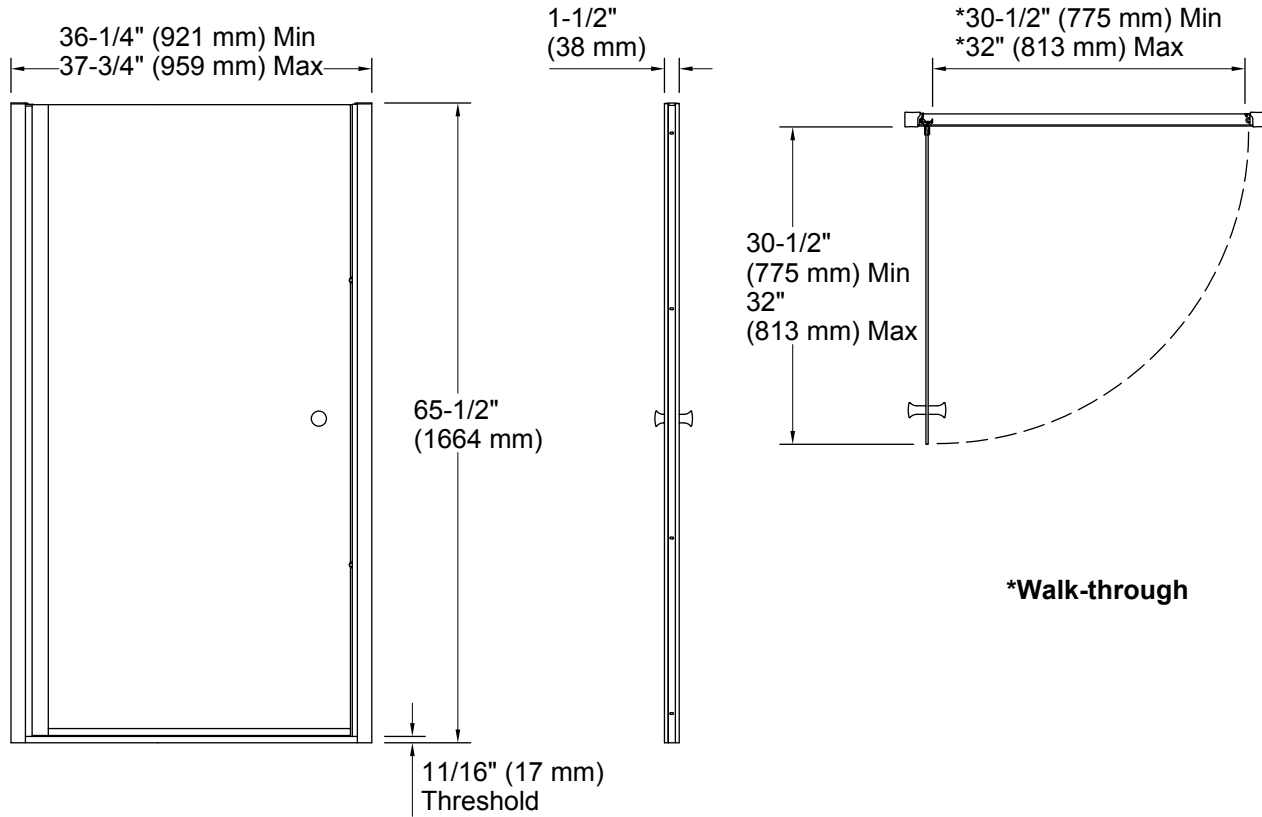

***Walk-through**

Technical Information

All product dimensions are nominal.

Installation type: For shower base installation

Opening Width - Min: 36-1/4" (921 mm)

Opening Width - Max: 37-3/4" (959 mm)

Walk-through - Min: 30-1/2" (775 mm)

Walk-through - Max: 32" (813 mm)

Glass thickness: 1/4" (6 mm)

Glass coating: CleanCoat®

Notes

Install this product according to the installation guide.

The vertical opening should be a minimum of 66" (1676 mm) to allow for installation clearance.