

380-387 SUMMIT® 1.28



Round Front, Vitreous China, Two-Piece Toilet

FEATURES

- High performance MagnaFlush™ flushing technology
- SmartFasten™ 3-bolt tank-to-bowl connection
- 1.28 gpf / 4.8 lpf low water consumption
- Round front bowl
- PuraClean® easy-to-clean glaze
- Pilot operated anti-siphon fill valve
- 3" Rigid Flapper flush valve – requires less force to flush, is more consistent and uses a simple universal repair part/seal
- Model 57 chrome-plated, metal trip lever
- 12" rough-in
- 2" glazed trapway
- The Mansfield® limited lifetime warranty on china; Five-year limited warranty on tank trim
- Available in White, Biscuit and Bone



MODEL 380-387

Toilet seat not included

Available as CTK





ROUND



CTK

COMPONENTS

MODEL #	DESCRIPTION	CODES/STANDARDS
380-387	Round front, two-piece toilet. Less toilet seat and supply. Specify color.	  
380	Round front toilet bowl only. Less toilet seat. Specify color.	
387	Tank and cover only, with left hand, front-mount, chrome-plated, metal trip lever. Less supply. Specify color.	
TANK TRIM & REPLACEMENT PARTS		
57	Trip lever - chrome-plated, metal trip lever, left hand	
2036-1212	Summit® 1.28 rigid flapper flush valve	
2206	Pilot operated fill valve	
630-0030	Replacement flush valve seal	
386-LID	Tank lid	





380-387 SUMMIT® 1.28



Round Front, Vitreous China, Two-Piece Toilet

SPECIFICATIONS

MODEL #	DESCRIPTION	CODES/STANDARDS
380-387	Round front, (1.28 gpf/4.8 lpf) two-piece toilet	  

MATERIAL	Vitreous China
WATER PRESSURE RANGE	20 to 80 PSI
FLUSH SYSTEM	MagnaFlush™ flushing technology
WATER USAGE	1.28 gpf / 4.8 lpf
WATER SURFACE AREA	8' X 9'
ROUGH-IN	12'
MaP RATING	1,000 grams

TRAP DIAMETER	2'
TRAP SEAL	2-3/8'
SHIPPING WEIGHT	Model 380 - 49 lbs. (22.2 kg) Model 387 - 36 lbs. (16.3 kg)
WARRANTY	Vitreous China - Limited Lifetime Tank Trim - Limited Five Year

TANK OPTIONS	TECHNICAL INFORMATION				
<table border="1" style="width: 100%;"> <tbody> <tr> <td style="width: 15%;">387RH</td> <td>Variation of model 387, with right hand trip lever.</td> </tr> <tr> <td>387LT</td> <td>Variation of model 387, with tank liner.</td> </tr> </tbody> </table>	387RH	Variation of model 387, with right hand trip lever.	387LT	Variation of model 387, with tank liner.	<p>Note: these dimensions are nominal and subject to change without notice.</p>
387RH	Variation of model 387, with right hand trip lever.				
387LT	Variation of model 387, with tank liner.				

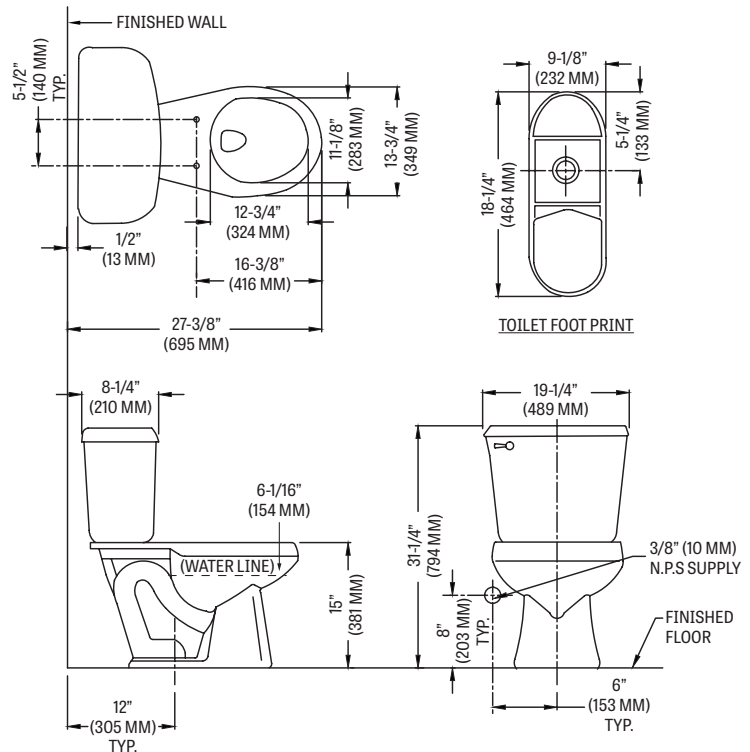

Fixture performance and specifications meet or exceed ASME A112.19.2-2013/CSA B45.1-13 standards, and other state and local codes.

